

RoHS

REV. ECN.NO. APPD.

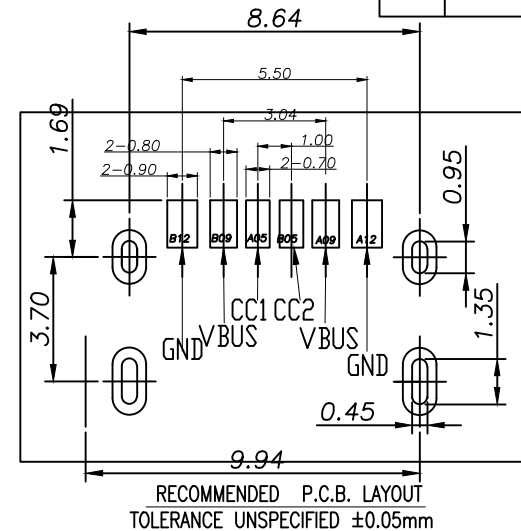

- NOTES:
- MATERIAL:
 - MOLDING: LCP UL94 V-0
 - CONTACT: COPPER ALLOY.
 - GOLD PLATED Min ON CONTACT AREA, 100u"
 - Min TIN (LEAD FREE) ON SOLDER AREA,
 - SHELL: SUS304-H,T=0.30±0.03mm
 - 50u" NICKEL PLATING OVER ALL.
 - MECHANICAL:
 - INSERTION: 5~20N.
 - EXTRACTION: 8~20N AFTER TEST.
 - DURABILITY: 10000 CYCLES
 - ELECTRICAL:
 - CURRENT: 5A FOR VBUS;
 - 1.25A FOR GND PIN.
 - 0.25A FOR OTHER.
 - VOLTAGE: 20 V MAX
 - WITHSTANDING VOLTAGE: 100V AC R.M.S.
 - CONTACT RESISTANCE: 40mΩ MAX.
 - INSULATION RESISTANCE: 100MΩ MIN.
 - ENVIRONMENTAL
 - TEMPERATURE RANGE -25°C ~ +85°C

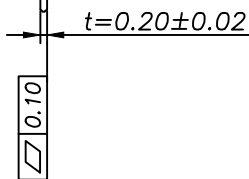
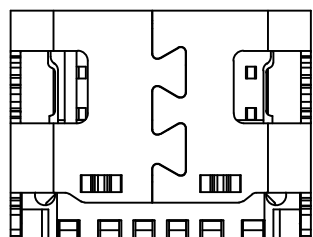
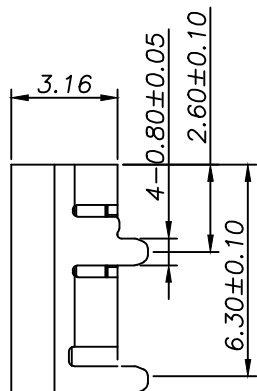
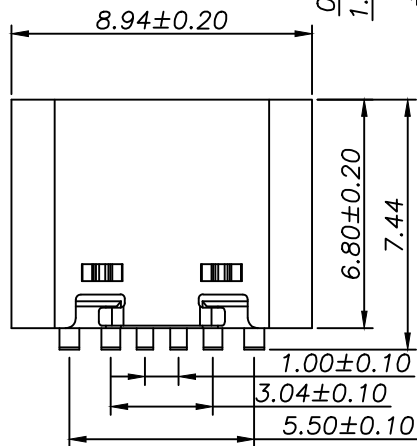
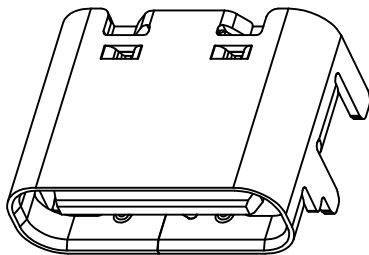
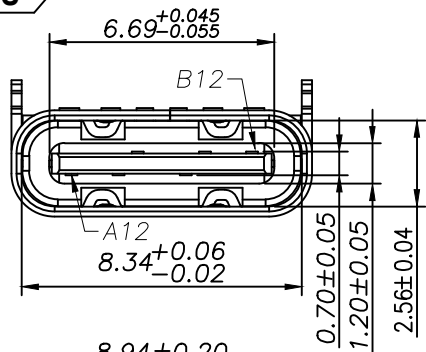
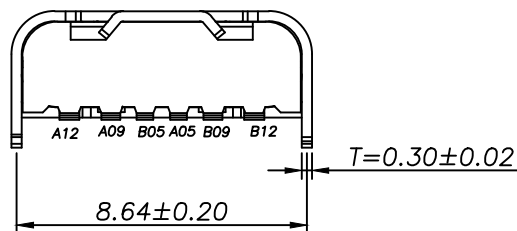

TABLE :

料号	REMARKS
ZX-TYPEC-WTM648	接触区金 G/F 锡脚
	接触区金 3u 锡脚

A1&B12	GND	C1
A4&B9	VBUS	C2
A5	CC1	C3
B5	CC2	C4
A9&B4	VBUS	C5
A12&B1	GND	C6
PIN	SIGNAL NAME	PCB PAD NO

NO.	DESCRIPTION	MATERIAL	REMARKS	QTY
4	SHELL	STAINLESS STEEL SUS201	Ni/SN Plated	1PCS
3	MID PLATE	STAINLESS STEEL SUS304	---	1PCS
2	CONTACT	COPPER ALLOY C2680 EH	C2680 EH (SEE TABLE)/NI50U"/SN 80U" Plated	1SET
1	HOUSING	HIGH TEMPERATURE PLASTIC	BLACK	1PCS

TOLERANCE UNLESS OTHERWISE SPECIFIED	
.XXX ±0.10	.X' ±3'
.XX ±0.20	.XX' ±2'
.X ±0.30	



兆星精密电子 (深圳) 有限公司

APPROVED		PART NAME:	Type-C			
CHECKED		PART No:	ZX-TYPEC-WTM648			C
DRAWN	Lin R	PROJECTION:	UNIT:	SCALE	SHEET	REV.
DATE	23/05/21		mm	1:1	1 OF 1	A