

DC Axial Fan  
**D1751S**

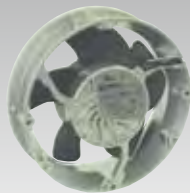

$\phi 172 \times 51$   
( $\phi 6.8'' \times 2.0''$ )  
Max. airflow : 14 m<sup>3</sup>/min  
Max. static pressure : 640 Pa  
Mass : 830 g

Fan model code

- D1751S24B9ZP300
- D1751S24B6ZP-00
- D1751S24B4AZ-00
- ~~D1751S24B4ZR-13~~
- D1751S24B3AZ-00
- D1751S12B2AZ-00
- D1751S24B2AZ-00
- D1751S24B2AP-00

Standard specification

Max. airflow		Max. static pressure		Noise	Speed	Voltage spec. V		Current mA		Model code	Operating Temp. Range °C
m <sup>3</sup> /min	CFM	Pa	inH <sub>2</sub> O	dB	min <sup>-1</sup>	Rating	Operating Range	Rating	Starting		
14.2	501	640	2.57	68	6800	24	16-28	4600	6900	<b>D1751S24B9ZP300</b>	-20 ~ +60
10.2	360	335	1.35	59	4800	24	12-27.6	1800	3200	<b>D1751S24B6ZP-00</b>	
8	282	220	0.88	53.5	3800	24	12-27.6	900	2200	<b>D1751S24B4AZ-00</b>	
6.8	240	165	0.66	48	3200	24	12-27.6	600	2400	<b>D1751S24B3AZ-00</b>	-20 ~ +70
5.8	205	125	0.50	44	2800	12	8.4-13.8	800	2900	<b>D1751S12B2AZ-00</b>	
						24	12-27.6	400	1900	<b>D1751S24B2AZ-00</b>	

- Figures in the table are average measured values. Please request the product delivery specification when preparing a purchase specification.
- The characteristics are the values at rated voltage (12 V, 24 V), and normal temperature and humidity.

General specification

Materials Used	Venturi: Aluminum alloy die castings Propelle: ABS and PBT synthetic resins Bearing: Both side shielded ball bearing
Motor	Brushless DC motor, Protection type: Overcurrent detection and automatic resetting by current limiting
Common Elec. Spec.	See pages G-11, G-12, G-13.
Standard Carton	12 to a carton of (450 x 380 x 220)mm, mass 10.5kg

Mouting hole dimensions in mm (inches) [Recommendation]

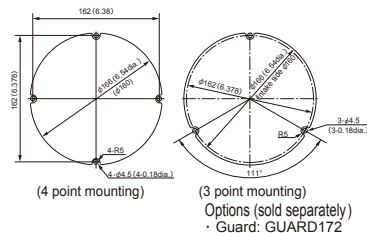

Standard airflow and static pressure characteristics (At rated voltage)

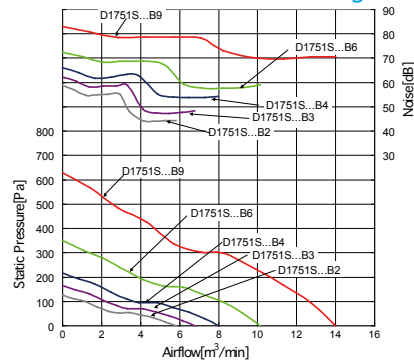

External dimensions in mm (inches)

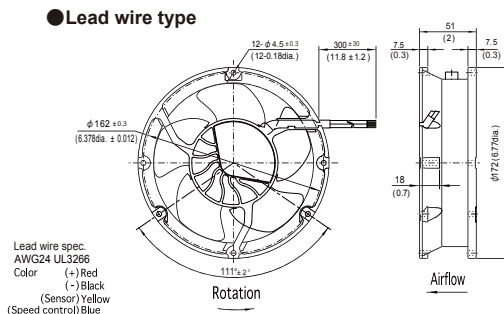

PWM speed control specification

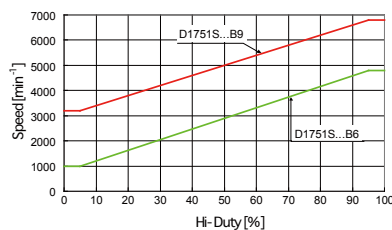

Speed Performance (At rated vol. Air) Specification (Room temperature)

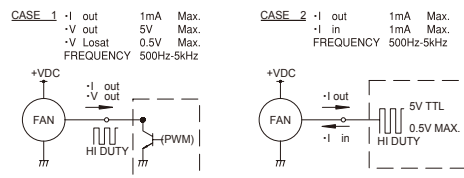

DC axial fan with sensor

Rated Vol.	Model Code
24 V	D1751S24B9ZP300
	D1751S24B6ZP-00
	D1751S24B2AP-00

**\* For red-lines product, Discontinued.**

- NIDEC SERVO can meet many of your requirements for customization, such as special connectors, other sensors not listed above, variable speed specifications, and other modifications. Please contact NIDEC SERVO during your product planning and development stage.
- PWM (pulse width modulation) allowing for variable speed control is available in some models (reference the G-51 spec.)
- The listed products are registered in the following overseas standards files, UL/cUL: E48889, TUV: R50004410

Fan model code

D0925C12B8ZP-00
D0925C24B8ZP-00
D1225C12BBZP-00
D1225C24BBZP-00
<del>D1238B48B7ZP-00</del>
D1751M48B6ZP-00
<del>D1751M24B5ZP-00</del>
D1751S24B9ZP300
D1751S24B6ZP-00
G0938B48B9ZP-00
G0938B12B8ZP-00
G1238B12BBZP-00
G1238B24BBZP-00
G1238B48BBZP-00
G1238B24BAZP-00
G1751M24B9ZP300
G1751M48B9ZP-00

Blowers

E1033L12BFZP-00
E1033L12BEZP-00
E1033H24BAZP-00
E2271Z48B7ZP-00

## Lineup of PWM variable-speed semi-standard products

- A PWM signal from the customer equipment is input to the control line (blue) of the fan motor for variable-speed operation of fans and blowers. (Input and noise can be reduced when the internal temperature of the customer equipment is low, such as during idling.)
- Sizes  
Axial fans: □92 mm~□172 mm  
Blower: □97 mm~φ220 mm

## Characteristics for reference (The characteristics are typical characteristics and their curves will differ, depending on the particular model)

- Standard values for PWM control signal - speed specification (at rated voltage, open, and normal temperature and humidity)

I <sub>out</sub>	1 mA MAX.
V <sub>out</sub>	5 V MAX.
V <sub>LOsat</sub>	0.4 MAX.
Freq.	500 Hz~5000 Hz

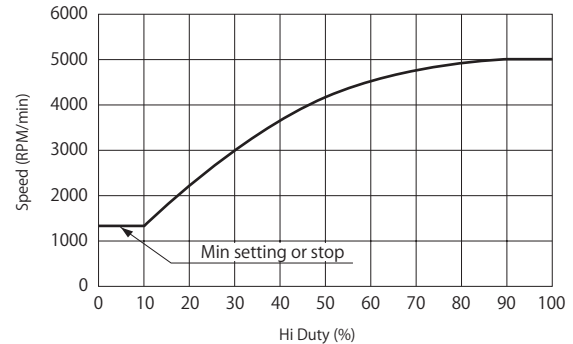
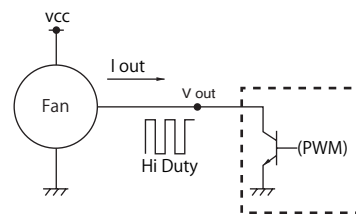

## Semi-standard products (Products in regular production)

Size	Model Code	Max. Airflow		Max. Static Pressure		Noise	Speed min <sup>-1</sup>		Voltage Spec. V		Operating Temp. Range °C
		m <sup>3</sup> /min	CFM	Pa	inH <sub>2</sub> O		Max.	Min.	Rating	Operating Range	
□92×25mm	D0925C12B8ZP-00	2	71	67	0.27	40	4450	1000	12	10.2-13.2	-20 ~ 60°C
	D0925C24B8ZP-00						4450	1750	24	21.6-26.4	
□120×25mm	D1225C12BBZP-00	4.25	150.1	150	0.6	50.5	5400	1000	12	10.2-13.8	-20 ~ 60°C
	D1225C24BBZP-00								24	20.4-27.6	
□119×38mm	<del>D1238B48B7ZP-00</del>	4.4	155	170	0.68	54	4000	1250	48	40.8-55.2	-20 ~ 70°C
φ172×150×51mm	D1751M48B6ZP-00	10.2	360	315	1.27	64	4800	1000	48	36-60	-20 ~ 70°C
	<del>D1751M24B5ZP-00</del>	9	318	260	1.04	61	4200	1000	24	12-27.6	
φ172×51mm	D1751S24B9ZP300	14.2	501	640	2.57	68	6800	3200	24	16-28	-20 ~ 60°C
	D1751S24B6ZP-00	10.2	360	335	1.35	59	4800	1000	24	12-27.6	
□92×38mm	G0938B48B9ZP-00	3.6	127	440	1.77	61	7000	2000	48	36-55.2	-20 ~ 60°C
	G0938B12B8ZP-00	3.2	113	350	1.41	58	6300	1600	12	8.4-13.8	
□119×38mm	G1238B12BBZP-00	7.4	261	520	2.09	67	6300	1000	12	9.6-13.8	-20 ~ 60°C
	G1238B24BBZP-00								24	16.8-27.6	
	G1238B48BBZP-00								48	36-55.2	
	G1238B24BAZP-00								24	16.8-27.6	
φ172×150×51mm	G1751M24B9ZP300	11.2	395	780	3.13	74	6800	3200	24	16-28	-20 ~ 70°C
	G1751M48B9ZP-00								48	36-60	
97×95×33mm	E1033L12BFZP-00	1.55	55	1400	5.63	66	6900	1800	12	10.8-12.6	-20 ~ 70°C
	E1033L12BEZP-00	1.45	51	1200	4.82	64	6400	1600	12	10.8-13.2	
	E1033H24BAZP-00	1.14	40	500	2.01	58	4850	1800	24	16-26.4	
φ220×71mm	E2271Z48B7ZP-00	18.1	639	600	2.41	74	3200	1000	48	36-57	-20 ~ 60°C

**\* For red-lines product, Discontinued.**

- Aside from the above models, please see also the high pressure, variable speed G series fans. Details may be found in specs G-31 to G-36.
- The lineup of variable-speed fans and blowers will be expanded regularly. Visit the NIDEC SERVO Website for information on the latest lineup.
- Direct your inquiry to NIDEC SERVO for connector termination to lead wires, for sensor specifications other than those contained in the catalog and for variable speed specifications. (Products tailored to voltage command control and resistance value command control are also available)
- To ensure correct installation and smooth operation please obtain a drawing for approval or reference drawing from NIDEC SERVO Co.

**F60P Guard (Mass 4 g)**

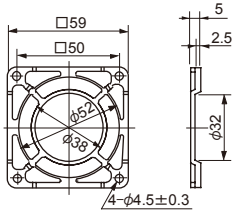

Material: Polycarbonate (black)  
UL94V-2

**F60UL Guard (Mass 12 g)**

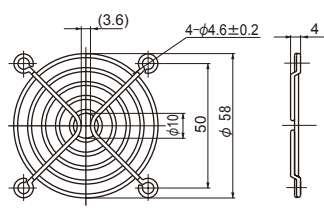

Material: Mild steel wire 1.6 dia.  
Surface treatment:  
Nickel chromium plating

**F80UL Guard (Mass 14 g)**

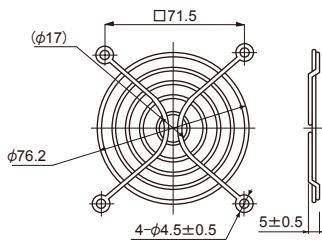

Material: Mild steel wire 1.6 dia.  
Surface treatment:  
Nickel chromium plating

**F92UL Guard (Mass 16 g)**

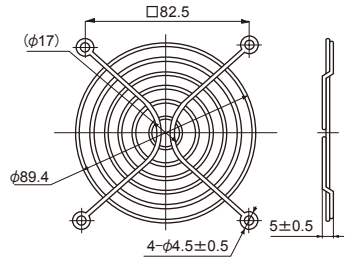

Material: Mild steel wire 1.6 dia.  
Surface treatment:  
Nickel chromium plating

**F120UL Guard (Mass 29 g)**

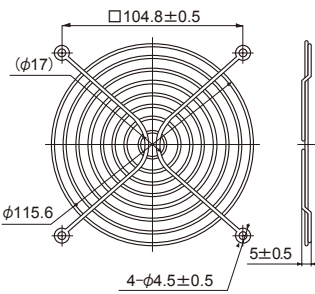

Material: Mild steel wire 1.6 dia.  
Surface treatment:  
Nickel chromium plating

**F127UL Guard**

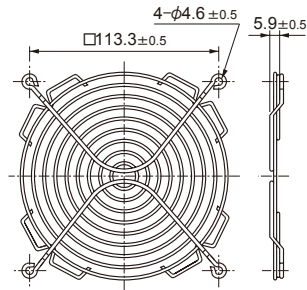

Material: Mild steel wire 1.6 dia.  
Surface treatment:  
Nickel chromium plating

**GUARD 172**

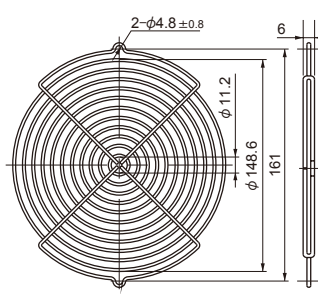

Material: Mild steel wire 2 dia.  
Surface treatment:  
Nickel chromium plating

**F180UL Guard**

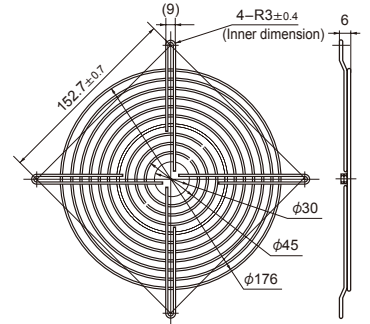

Material: Mild steel wire 1.6 dia.  
Surface treatment:  
Nickel chromium plating

**F200UL Guard (Mass 82 g)**

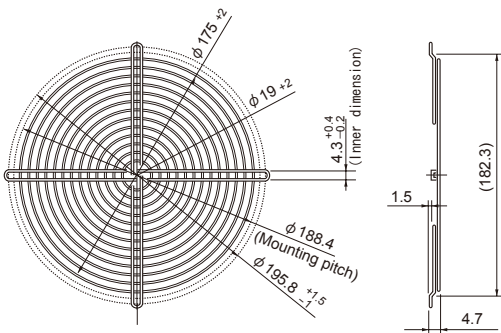

Material: Mild steel wire 1.6 dia.  
Surface treatment:  
Nickel chromium plating

**SCN Guard (Mass 55 g)**

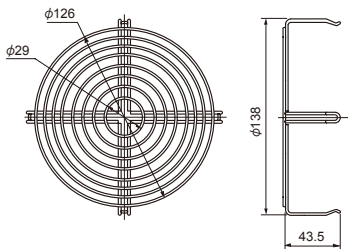

Material: Mild steel wire 1.6 dia.  
Surface treatment:  
Nickel chromium plating

- Guard special for intake side of SCN (metal venturi) fans.

List of mating fan series

Guard	F60P	F60UL	F80UL	F92UL	F120UL	F127UL	GUARD 172	F180UL	F200UL	SCN
AC Axial Fans										
SCN					○*1					○*2
VE			○							
WE				○						
KA				○						
CU					○					
CN					○					
MA							○			
PA							○			
DC Axial Fans										
TUDC	○	○								
PUDC			○							
D0925C				○						
KLDC				○						
D1225C					○					
CNDC					○					
D1238B					○					
D1338B						○				
D1751M							○			
D1751S							○			
G0638D		○								
G0838X			○							
G0938B				○						
G1238B					○					
G1751M							○			

\*1: Can be installed only on outlet side. \*2: Can be installed only on intake side. All guards conform to the UL standard when combined with NIDEC SERVO fans. The installation of a filter, guard and other accessories will constitute a ventilating load, reducing the airflow. Select a suitable guard, taking into consideration the increase in air resistance. (See Figs. 12 and 13 on page G-7.)

DC axial fans & blowers with sensors

The DC fans and blowers of NIDEC SERVO have a function to send an alarm signal when the fan motor revolutions slow down. Several systems are used to cut off the system power supply by this alarm signal, with three types of sensors available. Select the right type of sensor in accordance with the purpose of use. The lead wire for the sensor is yellow. The output type is an open collector output for all three types.

■ Sensor type

1. Lock detection type (Product code: S)

The output signal indicates an [L] state (transistor is ON) while the propeller is rotating, changing to an [H] state (transistor is OFF) less than five seconds after the propeller stops rotating. The propeller automatically restarts operation within five seconds when the lock is unlocked. ([H] → [L] 5 s). If the pull-up voltage is live, the [H] state (transistor is OFF) will engage in less than five seconds, even when the power is turned off.

- Specification:  $V_{CE} = 28\text{ V max}$  (55.2 V max for 48 V products)  
 $I_C = 5\text{ mA max}$   
( $V_{CE(SAT)} = 0.4\text{ V max}$ )
- Output waveform

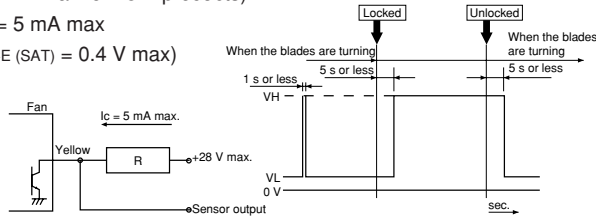

※When the power is turned on, the state sometimes becomes high [H] for several hundred ms.

2. Pulse output type (Product code: P)

A rectangular wave of two pulses will be output for each turn of the propeller while the propeller is rotating, outputting two types of signal depending on the propeller position when the propeller is locked. (See the note below ※)

- Specification:  $V_{CE} = 28\text{ V max}$  (55.2 V max for 48 V products)  
 $I_C = 5\text{ mA max}$   
( $V_{CE(SAT)} = 0.4\text{ V max}$ )
- Output waveform

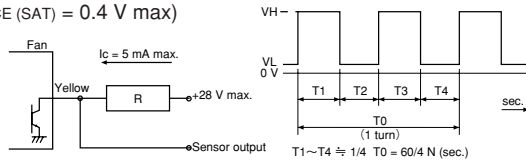

※Output signal waveform when the fan is stopped: The following two types of waveform are output, depending on the blade position when the propeller is stopped:  
Pulse outputs of High - constant or restart timing (0.05 Hz to 2 Hz).

3. Speed detection type (Product code: Q)

The output signal indicates the [H] state when the propeller revolutions are slower than the preset speed, changing to the [L] state when the propeller revolutions exceed the reset speed.

[Products with a reversed output waveform are also available, suitable for a wired OR connection when several fans are installed. Contact NIDEC SERVO for further information. {Former code: SQ, new code (15 - digit code products): R}]

- Specification:  $V_{CE} = 28\text{ V max}$  (55.2 V max for 48 V products)  
 $I_C = 5\text{ mA max}$   
( $V_{CE(SAT)} = 0.4\text{ V max at } 5\text{ mA}$ )

● Output waveform

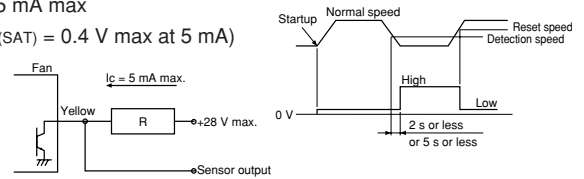

Note: The output waveform for type SQ (R) will be reversed. The speed setting for the alarm output is about half the rated speed. For more detailed information, please request a product delivery specification from NIDEC SERVO.